



English

**VISION:elite™**

**4M Resolution CMOS**

**B/W Camera Link**

**VCC-GC60FR11CL**

**Product Specification**  
**& Operational Manual**

**CIS Corporation**

## Table of Contents

PAGE

1.	Scope of Application .....	3
2.	Handling Precautions .....	3
3.	Product Outline .....	4
4.	Specification.....	5
4.1.	General Specification .....	5
4.2.	Camera Output Signal Specification .....	7
4.3.	CMOS Spectral Response (Representative Value) .....	8
4.4.	Video Output Format .....	9
5.	Function Settings.....	10
6.	External Connector Pin Assignment.....	13
6.1.	12 pins Circular Connector HR10-10R-12PA (HIROSE) equivalent.....	13
6.2.	Camera Link Connector 12226-1100-00PL (SUMITOMO 3M).....	14
6.3.	PoCL Selection Switch (SW1).....	14
7.	Timing Chart .....	15
7.1.	Horizontal Synchronous Signals Timing (1Tap Base Configuration Mode: 17fps) .....	15
7.2.	Vertical Synchronous Signals Timing (1Tap Base Configuration Mode: 17fps).....	15
7.3.	Horizontal Synchronous Signals Timing (2Tap Base Configuration Mode: 34fps) .....	16
7.4.	Vertical Synchronous Signals Timing (2Tap Base Configuration Mode: 34fps).....	16
7.5.	Horizontal Synchronous Signals Timing (4Tap Medium Configuration Mode: 68fps) * Initial Setting .....	17
7.6.	Vertical Synchronous Signals Timing (4Tap Medium Configuration Mode: 68fps).....	17
7.7.	Horizontal Synchronous Signals Timing (8Tap Full Configuration Mode: 135fps) .....	18
7.8.	Vertical Synchronous Signals Timing (8Tap Full Configuration Mode: 135fps).....	18
7.9.	Fixed Trigger Shutter Mode .....	19
7.10.	Pulse Width Trigger Shutter Mode.....	20
7.11.	Internal Trigger Mode .....	21
8.	Partial Scan Mode .....	22
9.	Remote Communication Function.....	24
10.	Initial Settings .....	26
11.	CMOS Optical Axis Accuracy .....	27
12.	Dimensions .....	28
13.	Cases for Indemnity (Limited Warranty) .....	29
14.	CMOS Pixel Defect .....	29
15.	Product Support .....	29

## 1. Scope of Application

This is to describe VCC-GC60FR11CL, 4M resolution, Camera Link B/W CMOS Camera.

All specifications contained herein are subject to change without prior notice. Reproduction in whole or in part is prohibited.

## 2. Handling Precautions

The camera must not be used for any nuclear equipments or aerospace equipments with which mechanical failure or malfunction could result in serious bodily injury or loss of human life. Our warranty does not apply to damages or defects caused by irregular and/or abnormal use of the product.

Please observe all warnings and cautions stated below.

Our warranty does not apply to damages or malfunctions caused by neglecting these precautions.

- Do not use or store the camera in the following extreme conditions:
  - Extremely dusty or humid places.
  - Extremely hot or cold places (operating temperature  $-5^{\circ}\text{C}$  to  $+45^{\circ}\text{C}$ )
  - Close to generators of powerful electromagnetic radiation such as radio or TV transmitters.
  - Places subject to fluorescent light reflections.
  - Places subject to unstable (flickering, etc.) lighting conditions.
  - Places subject to strong vibration.
  
- Remove dust or dirt on the surface of the lens with a blower.
  
- Do not apply excessive force or static electricity that could damage the camera.
  
- Do not shoot direct images that are extremely bright (e.g., light source, sun, etc.), and when camera is not in use, put the lens cap on.
  
- Follow the instructions in Chapter 6, "External connector pin assignment" for connecting the camera. Improper connection may cause damages not only to the camera but also to the connected devices.
  
- Confirm the mutual ground potential carefully and then connect the camera to monitors or computers. AC leaks from the connected devices may cause damages or destroy the camera.
  
- Do not apply excessive voltage. (Use only the specified voltage.) Unstable or improper power supply voltage may cause damages or malfunction of the camera.

- The voltage ripple of camera power DC +12V±10% shall be within ±50mV. Improper power supply voltage may cause noises on the video signals.
- The rising time of camera power supply voltage shall be less than +10V, Max 60ms. Please avoid noises like chattering when rising.

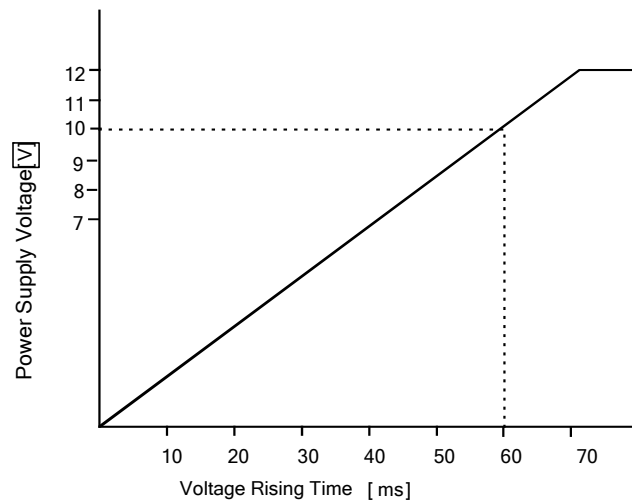

### 3. Product Outline

VCC-GC60FR11CL is a Camera Link interfaced and 4M resolution industrial black and white video camera module. 4M pixels CMOS sensor with diagonal length 15.930mm is utilized. Entire pixels can be read out within 1/68s at Medium Configuration output.

#### Features

- Global shutter CMOS sensor is utilized.
- Camera Link Base, Medium, and Full Configuration are supported.
- Fixed trigger shutter mode, pulse width trigger shutter mode, and internal trigger mode are operable.
- Full frame rates and video output format are as follows.

1Tap Base Configuration Mode	17fps	8bit/10bit
2Tap Base Configuration Mode	34fps	8bit/10bit
4Tap Medium Configuration Mode	68fps(Initial Setting)	8bit/10bit
8Tap Full Configuration Mode	135fps	8bit
Factory Setting: 4 Tap Medium	68fps	8bit

- Free Software
  - CIS control panel software for evaluation purpose only is downloadable via our web.
- Optional Accessories
  - Mount conversion ring from M42 to C mount
  - Mount conversion ring from M42 to F mount

## 4. Specification

## 4.1. General Specification

(1) Pickup Device	Device Type Effective pixel number Unit cell size	Diagonal Length 15.930mm, Global Shutter type, B/W CMOS 2048(H) x 2048(V) 5.5 $\mu$ m(H) x 5.5 $\mu$ m(V)
(2) Video Output Frequency	Pixel Clock	72 MHz
	1Tap Base Configuration Mode:	Horizontal frequency: 34.884 kHz    Horizontal clock 2064 CLK Vertical frequency: 16.992 Hz    Scanning lines 2053 H
	2Tap Base Configuration Mode:	Horizontal frequency: 69.767 kHz    Horizontal clock 1032 CLK Vertical frequency: 33.967 Hz    Scanning lines 2054 H
	4Tap Medium Configuration Mode:	Horizontal frequency: 139.535 kHz    Horizontal clock 516 CLK Vertical frequency: 67.834 Hz    Scanning lines 2057 H
	8Tap Full Configuration Mode:	Horizontal frequency: 279.070 kHz    Horizontal clock 258 CLK Vertical frequency: 135.339 Hz    Scanning lines 2062 H
(3) Sync. System	Internal Sync. System.	
(4) Video Output	1Tap Base Configuration 2Tap Base Configuration 4Tap Medium Configuration (Initial Setting) 8Tap Full Configuration	
(5) Resolution	2048 TV Lines	
(6) Output Format	Sensor AD Camera Link output	10bit 8bit / 10bit (Fixed to 8bit at Full Configuration mode.) Monochrome output.
(7) Sensitivity	F5.6 400lx (at Shutter speed 1/68s (OFF), Gain 0dB, and Medium Configuration mode)	
(8) Minimum illumination	F1.4 1.5lx (at Shutter speed 1/68s (OFF), Gain +12dB, and Medium Configuration mode)	
(9) Dust or stains in optical system	No dust or stain shall be detected on the testing screen with setting the camera aperture at F16.	
(10) Power requirements	DC+12V $\pm$ 10% 12pins circular connector or PoCL	
(11) Power consumption	2.0W (at DC+12V IN, 4Tap Medium Configuration mode, Full frame scan output): Initial setting. 3.0W (at DC+12V IN, 8Tap Full Configuration mode, Partial scan 10lines output)	
(12) Dimensions	Refer to overall dimension drawing. (H:55mm W:55mm D:25mm excluding projection)	
(13) Weight	Approx. 125g	
(14) Lens mount	M42 Mount * Refer to overall dimension drawing.	
(15) Optical axis accuracy	Refer to drawing for CMOS Optical Axis Accuracy.	
(16) Gain variable range	0dB ~ +12dB (Guaranteed range)	
(17) Shutter speed variable range	OFF ~ 1/50000s	
(18) Trigger shutter mode	Fixed Shutter Trigger Mode/ Pulse Width Shutter Trigger Mode / Internal Trigger Mode	
(19) Partial Scan	Full Frame Scan ~ 1 line (1 line / step)	
(20) Safety/Quality standards	UL: Conform to UL Standard including materials and others. CE: EN55022:2006 Class B for Emission EN61000-6-2:2005 for Immunity RoHS: Conform to RoHS. FCC: To be applied to FCC Class A digital Device This device complies with Part 15 of the FCC Rules. Operation is subject to the following two conditions: (1) this device may not cause harmful interference, and (2) this device must accept any interference received, including interference that may cause undesired operation.	

(21) Durability	Vibration	Acceleration : 98m/s <sup>2</sup> (10G) Frequency : 20~200 Hz Direction : X,Y, and Z 3 directions Testing time : 120min for each direction
	Shock	No malfunction shall be occurred with 980m/s <sup>2</sup> (100G) for ±X,±Y, and ±Z, 6 directions. (without package)
(22) Operation environment	Temperature	Performance guaranteed temperature: 0°C~+40°C Camera operation guaranteed temepature: -5°C~+45°C ※ All the specifications specified in this manual is guaranteed under performance guaranteed temperature. ※All the camera functions operate normally under operation guaranteed temperature.
	Humidity	RH 20~80% with no condensation.
(23) Storage Environment	Temperature	-25°C~+60°C
	Humidity	RH 20~80% with no condensation.

4.2. Camera Output Signal Specification

(1) Video output data	Effective Video Output	2048(H) × 2048(V)	At full frame scan mode
(2) Sync. Signal output	General Purpose Output 1 : 6 pin General Purpose Output 2 : 7 pin General Purpose Output 3 : 9 pin General Purpose Output 4 : 10 pin	12pins Circular Connector (LVTTL output):	Selectable with Address 034, Address 035, Address 036, And Address 037
	LVAL FVAL DVAL SP		
(3) Trigger Input	Polarity	Positive/Negative Selectable	Polarity is selectable with Address 011
	Pulse Width	10μs (min.) ~ Approx. 2 frames Functionally, no upper limitation is set but noises such as dark noises and shadings might be noticeable at long time exposure.	
	Trigger Input : 11pin : CC1	12pins circular connector (LVTTL) Camera Link input (LVDS)	: Selectable with address 012.
(4) Partial Scan Selection	General Purpose Input 1 : 4pin	12pins circular connector (LVTTL input)	
(5) Serial Communication	SerTC (Serial to Camera)	Camera Link input (LVDS)	
	SerTFG (Serial to Frame Grabber)	Camera Link output (LVDS)	
(6) Video Signals	White Clip Level	At Digital 10bit	: 3FFh
	Setup Level	At Digital 10bit	: under 002h (Condition: Gain 0dB)
	Dark Shading	At Digital 10bit	: Both horizontal and vertical should be under ±00Fh. (Condition: Gain 0dB)

※ 2 seconds shall be waited after turning on power to get proper camera operation.

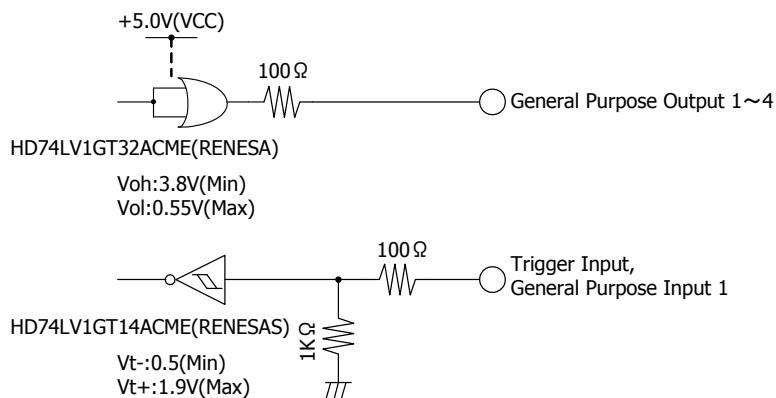

12pins circular connector at rear: IO Interface

## 4.3. CMOS Spectral Response (Representative Value)

\* Lens characteristics and luminous source characteristics are not considered.

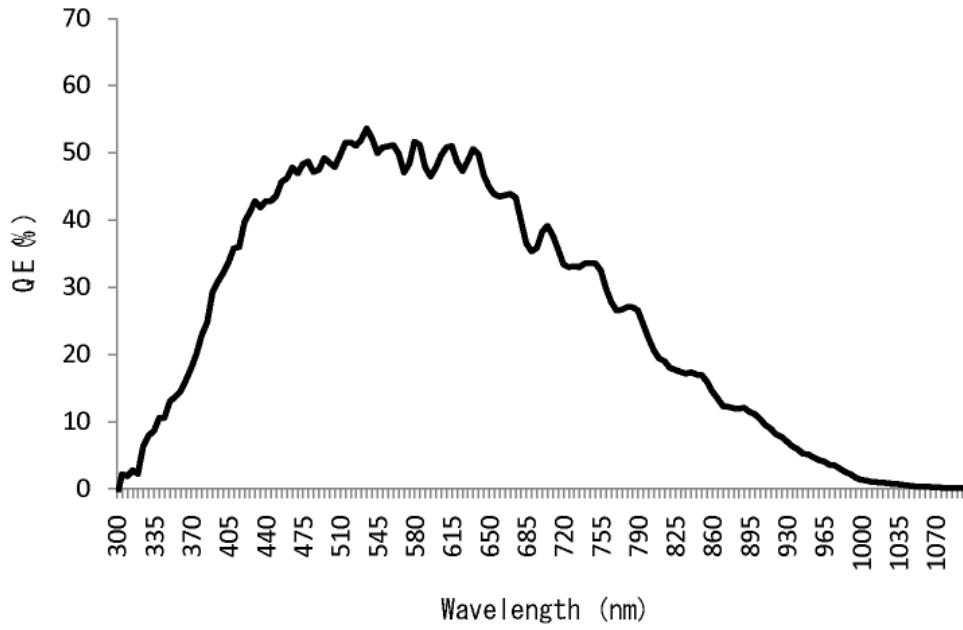



### 4.4 Video Output Format

(1) 1Tap Base Configuration Mode : 17fps

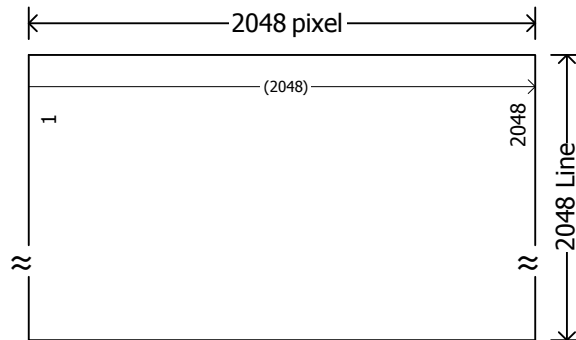

(2) 2Tap Base Configuration Mode : 34fps

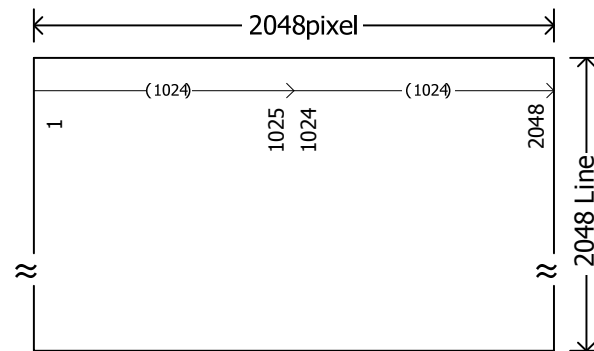

(3) 4Tap Medium Configuration Mode : 68fps (Initial Setting)

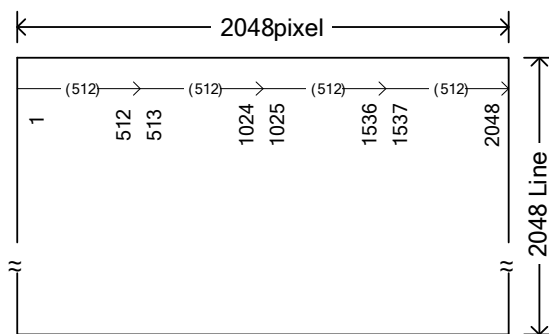

(4) 8Tap Full Configuration Mode : 135fps

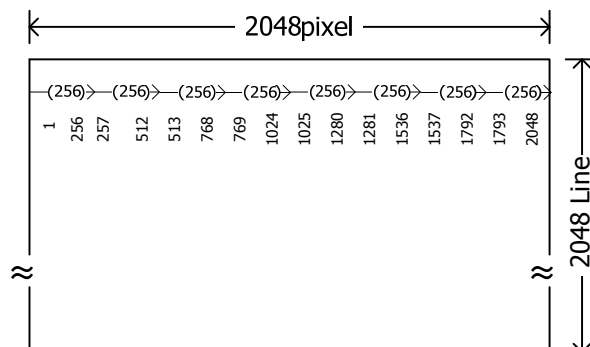

## 5. Function Settings

(Camera functions can be set with serial communications.)

Function	Address	Data																																																																																										
Gain	001	0: 0 dB : Fixed Gain 1: + 3 dB : Fixed Gain 2: + 6 dB : Fixed Gain 3: + 12 dB : Fixed Gain 4: Manual Gain: over 0~+12dB (Refer to Address 005 and 006.)																																																																																										
Shutter	002	<table border="1"> <thead> <tr> <th></th> <th>1Tap Mode</th> <th>2Tap Mode</th> <th>4Tap Mode</th> <th>8Tap Mode</th> </tr> </thead> <tbody> <tr><td>0:</td><td>1/17s(OFF)</td><td>1/34s(OFF)</td><td>1/68s(OFF)</td><td>1/135s(OFF)</td></tr> <tr><td>1:</td><td>1/30s(OFF)</td><td>1/34s(OFF)</td><td>1/68s(OFF)</td><td>1/135s(OFF)</td></tr> <tr><td>2:</td><td>1/60s</td><td>1/60s</td><td>1/68s(OFF)</td><td>1/135s(OFF)</td></tr> <tr><td>3:</td><td>1/90s</td><td>1/90s</td><td>1/90s</td><td>1/135s(OFF)</td></tr> <tr><td>4:</td><td>1/120s</td><td>1/120s</td><td>1/120s</td><td>1/135s(OFF)</td></tr> <tr><td>5:</td><td>1/150s</td><td>1/150s</td><td>1/150s</td><td>1/150s</td></tr> <tr><td>6:</td><td>1/250s</td><td>1/250s</td><td>1/250s</td><td>1/250s</td></tr> <tr><td>7:</td><td>1/500s</td><td>1/500s</td><td>1/500s</td><td>1/500s</td></tr> <tr><td>8:</td><td>1/1000s</td><td>1/1000s</td><td>1/1000s</td><td>1/1000s</td></tr> <tr><td>9:</td><td>1/2500s</td><td>1/2500s</td><td>1/2500s</td><td>1/2500s</td></tr> <tr><td>10:</td><td>1/5000s</td><td>1/5000s</td><td>1/5000s</td><td>1/5000s</td></tr> <tr><td>11:</td><td>1/10000s</td><td>1/10000s</td><td>1/10000s</td><td>1/10000s</td></tr> <tr><td>12:</td><td>1/20000s</td><td>1/20000s</td><td>1/20000s</td><td>1/20000s</td></tr> <tr><td>13:</td><td>1/30000s</td><td>1/30000s</td><td>1/30000s</td><td>1/30000s</td></tr> <tr><td>14:</td><td>1/45000s</td><td>1/45000s</td><td>1/45000s</td><td>1/45000s</td></tr> <tr><td>15:</td><td>1/50000s</td><td>1/50000s</td><td>1/50000s</td><td>1/50000s</td></tr> <tr><td>16:</td><td colspan="4">Manual Shutter (Refer to Address 009 and 010.)</td></tr> </tbody> </table>		1Tap Mode	2Tap Mode	4Tap Mode	8Tap Mode	0:	1/17s(OFF)	1/34s(OFF)	1/68s(OFF)	1/135s(OFF)	1:	1/30s(OFF)	1/34s(OFF)	1/68s(OFF)	1/135s(OFF)	2:	1/60s	1/60s	1/68s(OFF)	1/135s(OFF)	3:	1/90s	1/90s	1/90s	1/135s(OFF)	4:	1/120s	1/120s	1/120s	1/135s(OFF)	5:	1/150s	1/150s	1/150s	1/150s	6:	1/250s	1/250s	1/250s	1/250s	7:	1/500s	1/500s	1/500s	1/500s	8:	1/1000s	1/1000s	1/1000s	1/1000s	9:	1/2500s	1/2500s	1/2500s	1/2500s	10:	1/5000s	1/5000s	1/5000s	1/5000s	11:	1/10000s	1/10000s	1/10000s	1/10000s	12:	1/20000s	1/20000s	1/20000s	1/20000s	13:	1/30000s	1/30000s	1/30000s	1/30000s	14:	1/45000s	1/45000s	1/45000s	1/45000s	15:	1/50000s	1/50000s	1/50000s	1/50000s	16:	Manual Shutter (Refer to Address 009 and 010.)			
	1Tap Mode	2Tap Mode	4Tap Mode	8Tap Mode																																																																																								
0:	1/17s(OFF)	1/34s(OFF)	1/68s(OFF)	1/135s(OFF)																																																																																								
1:	1/30s(OFF)	1/34s(OFF)	1/68s(OFF)	1/135s(OFF)																																																																																								
2:	1/60s	1/60s	1/68s(OFF)	1/135s(OFF)																																																																																								
3:	1/90s	1/90s	1/90s	1/135s(OFF)																																																																																								
4:	1/120s	1/120s	1/120s	1/135s(OFF)																																																																																								
5:	1/150s	1/150s	1/150s	1/150s																																																																																								
6:	1/250s	1/250s	1/250s	1/250s																																																																																								
7:	1/500s	1/500s	1/500s	1/500s																																																																																								
8:	1/1000s	1/1000s	1/1000s	1/1000s																																																																																								
9:	1/2500s	1/2500s	1/2500s	1/2500s																																																																																								
10:	1/5000s	1/5000s	1/5000s	1/5000s																																																																																								
11:	1/10000s	1/10000s	1/10000s	1/10000s																																																																																								
12:	1/20000s	1/20000s	1/20000s	1/20000s																																																																																								
13:	1/30000s	1/30000s	1/30000s	1/30000s																																																																																								
14:	1/45000s	1/45000s	1/45000s	1/45000s																																																																																								
15:	1/50000s	1/50000s	1/50000s	1/50000s																																																																																								
16:	Manual Shutter (Refer to Address 009 and 010.)																																																																																											
Trigger Shutter Mode	004	0: Normal Shutter Mode (Trigger OFF) 1: Fixed Trigger Shutter Mode (Shutter speed can be set with address 002.) 2: Pulse Width Trigger Shutter Mode (Shutter speed can be set with trigger pulse width.) 5: Internal Fixed Trigger Shutter Mode (According to external trigger signals, the specified numbers of trigger are generated in the camera.) 6: Internal Pulse Width Trigger Shutter Mode (According to external trigger signals, the specified numbers of trigger are generated in the camera.)																																																																																										
Manual Gain	005&006	0~767: 0:0dB ~ 767:+12dB																																																																																										
Manual Shutter	009&010	$\text{Shutter Speed} = 15.41\mu\text{s} + (\text{Max Data} - (009\&010)) \times 3.583\mu\text{s}$ <table border="1"> <thead> <tr> <th></th> <th>1Tap Mode</th> <th>2Tap Mode</th> <th>4Tap Mode</th> <th>8Tap Mode</th> </tr> </thead> <tbody> <tr> <td>Mini Data</td> <td>0(58.7ms)</td> <td>0(29.4ms)</td> <td>0(14.7ms)</td> <td>0(7.3ms)</td> </tr> <tr> <td>Max Data</td> <td>16383(15.41us)</td> <td>8191(15.41us)</td> <td>4095(15.41us)</td> <td>2047(15.41us)</td> </tr> </tbody> </table> <p>※Set the data of address 002 to 016. Address 009 MSB and address 010 LSB makes total 16bit. ※b0-b1 shall be invalid at 1Tap normal shutter mode setting.</p>		1Tap Mode	2Tap Mode	4Tap Mode	8Tap Mode	Mini Data	0(58.7ms)	0(29.4ms)	0(14.7ms)	0(7.3ms)	Max Data	16383(15.41us)	8191(15.41us)	4095(15.41us)	2047(15.41us)																																																																											
	1Tap Mode	2Tap Mode	4Tap Mode	8Tap Mode																																																																																								
Mini Data	0(58.7ms)	0(29.4ms)	0(14.7ms)	0(7.3ms)																																																																																								
Max Data	16383(15.41us)	8191(15.41us)	4095(15.41us)	2047(15.41us)																																																																																								
Trigger Polarity	011	0: Positive 1: Negative																																																																																										

Function	Address	Data
Trigger Input	012	0: Camera Link (CC1) Input 1: 12pin Connector(11pin) Input
Output Data Selection	013	0: 8bit Output 1: 10bit output (10bit can not be output at 8Tap Full Configuration mode.)
Partial Scan Mode	015	0: Full Frame Scan Mode 1: Partial Scan Mode * To control partial scan mode with camera resistor, input "L" signal to the pin No. 4 of the 12pins circular connector, or disconnect.
Partial Scan Start Position 1	016&017	0~2047: ※Set the data of address 015 to 001. Address 016 MSB and address 017 LSB makes total 16bit.
Camera internal H Sync ON/OFF of trigger input signal	018	0: OFF 1: ON
Partial Scan Effective Line Number 1	019&020	0~2048: Set 0 when not in use. ※Set the data of address 015 to 001. Address 019 MSB and address 020 LSB makes total 16bit.
Output image flip vertical	021	0: Normal 1: Flip Vertical
General Purpose Input 1 ON/OFF	022	0: Invalid 1: Valid
Baud Rate	030	0: 9600bps 1: 19200bps 2: 38400bps 3: 57600bps 4: 115200bps
Camera Mode	031	0: 8Tap Full Configuration Mode (135fps) 1: 4Tap Medium Configuration Mode (68fps) 2: 2Tap Base Configuration Mode (34fps) 3: 1Tap Base Configuration Mode (17fps)
Exposure Polarity	032	0: Positive 1: Negative
General Purpose Output 1,	034	} 0: HD output 1: FVAL output 2: Exposure output 3: TRIG Input EN output 4: DVAL output 5: HD output
General Purpose Output 2,	035	
General Purpose Output 3,	036	
General Purpose Output 4	037	
Camera Link SP output	038	
Camera Link DVAL output	039	1: FVAL output 2: Exposure output 3: TRIG Input EN output 4: DVAL output 5: HD output
Internal Trigger Pulse Width	040&041	0 ~ 65535: Setting Conditions: Address (042&043) > Address (040&041) Pulse Width = ((Address (040&041)+1) x 3.583 μs
Internal Trigger Tact Time	042&043	1 ~ 65535: Setting Address (042&043) > 0, Conditions: Address (042&043) > Address (040&041) Tact Time = ((Address (042&043)+1) x 3.583 μs

Function	Address	Data
Internal Trigger Repeat number	044	0 ~ 31: Address (044)+1 time
Partial Scan Start Position 1	016&017	0~2047: Set the data of address 015 to 001. Address 016 MSB and address 017 LSB makes total 16bit.
Partial Scan Effective lines 1	019&020	1~2048: Set 0 when not in use. Set the data of address 015 to 001. Address 019 MSB and address 020 LSB makes total 16bit.
Partial Scan Start Position 2	207&208	0~2047:
Partial Scan Effective lines 2	209&210	1~2048: Set 0 when not in use.
Partial Scan Start Position 3	211&212	0~2047:
Partial Scan Effective lines 3	213&214	1~2048: Set 0 when not in use.
Partial Scan Start Position 4	215&216	0~2047:
Partial Scan Effective lines 4	217&218	1~2048: Set 0 when not in use.
Partial Scan Start Position 5	219&220	0~2047:
Partial Scan Effective lines 5	221&222	1~2048: Set 0 when not in use.
Partial Scan Start Position 6	223&224	0~2047:
Partial Scan Effective lines 6	225&226	1~2048: Set 0 when not in use.
Partial Scan Start Position 7	227&228	0~2047:
Partial Scan Effective lines 7	229&230	1~2048: Set 0 when not in use.
Partial Scan Start Position 8	231&232	0~2047:
Partial Scan Effective lines 8	233&234	1~2048: Set 0 when not in use.
Initial Settings	254	Input 083 or 053 to set back to initial settings.
Data Save	255	Input 083 or 053 to save the data to EEPROM.

※ The data set with 2 Byte shall be set with High Byte first, then set with Low Byte. The camera rewrites the internal register when receiving Low Byte.

6. External Connector Pin Assignment

6.1. 12 pins Circular Connector HR10-10R-12PA (HIROSE) equivalent

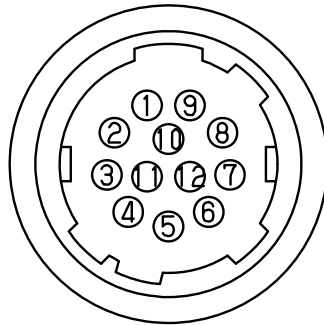

Pin No.		Initial Settings	
1	GND		
2	Power Input (DC+12V)		
3	GND		
4	General Purpose Input 1	Full frame scan / Partial scan	*1
5	GND		
6	General Purpose Output 1	HD output	(Address 034, data 0)*2
7	General Purpose Output 2	FVAL output	(Address 035, data 1)*2
8	GND		
9	General Purpose Output 3	Exposure output	(Address 036, data 2)*2
10	General Purpose Output 4	TRIG Input EN output	(Address 037, data 3)*2
11	Trigger Input		
12	GND		

\*1. General Purpose Input 1

Via 12pins connector, full frame scan mode and partial scan mode can be switched.

Input Signal	Function
L or NA	: Full Frame Scan Mode
H	: Partial Scan Mode

Set the resistor address 015 to data 0 (full frame scan mode).

When data 1 (partial scan mode) is set to the resistor address 015, 12pin connector control will be invalid.

\*2. General Purpose Output 1~4

The following output signals can be selected by serial communication commands.

Output Signals	Address	Data
Output 1	034	0: HD output
Output 2	035	1: FVAL output
Output 3	036	2: Exposure output
Output 4	037	3: TRIG Input EN output

## 6.2. Camera Link Connector 12226-1100-00PL (SUMITOMO 3M)

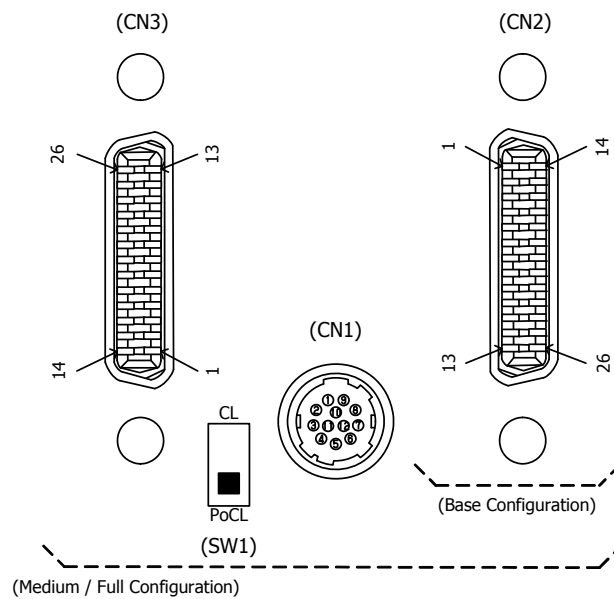

Connector (CN3)

Pin No.		Pin No.	
1	<b>NA</b>	14	<b>GND</b>
2	Y0-	15	Y0+
3	Y1-	16	Y1+
4	Y2-	17	Y2+
5	Yclk-	18	Yclk+
6	Y3-	19	Y3+
7	100Ω	20	Terminated
8	Z0-	21	Z0+
9	Z1-	22	Z1+
10	Z2-	23	Z2+
11	Zclk-	24	Zclk+
12	Z3-	25	Z3+
13	<b>GND</b>	26	<b>NA</b>

Connector (CN2)

Pin No.		Pin No.	
1	<b>GND/+12V(PoCL)</b>	14	<b>GND</b>
2	X0-	15	X0+
3	X1-	16	X1+
4	X2-	17	X2+
5	Xclk-	18	Xclk+
6	X3-	19	X3+
7	SerTC+	20	SerTC-
8	SerTFG-	21	SerTFG+
9	CC1- (Trigger IN -)	22	CC1+ (Trigger IN +)
10	100Ω	23	Terminated
11	100Ω	24	Terminated
12	100Ω	25	Terminated
13	<b>GND</b>	26	<b>GND/+12V(PoCL)</b>

## 6.3. PoCL Selection Switch (SW1)

(1) PoCL ... Set the switch when feeding power via the frame grabber board with PoCL supported.

※ When the switch is set to PoCL side, power feeding line of CN2 (on Base Configuration connector side) will be connected to the camera internal power input. At this time, power feeding line of CN3 (on Medium/Full Configuration connector side) shall be OPEN. When using at Medium/Full Configuration mode, please contact the frame grabber board manufacturer to make sure that there would be no problem with the above connection.

(2) CL ... Set the switch when using non-PoCL supported frame grabber board. Please make sure that the power of feeding side is OFF when changing the switch setting. If the switch setting is changed while power distribution, malfunction may occur.

### 7. Timing Chart

#### 7.1. Horizontal Synchronous Signals Timing (1Tap Base Configuration Mode: 17fps)

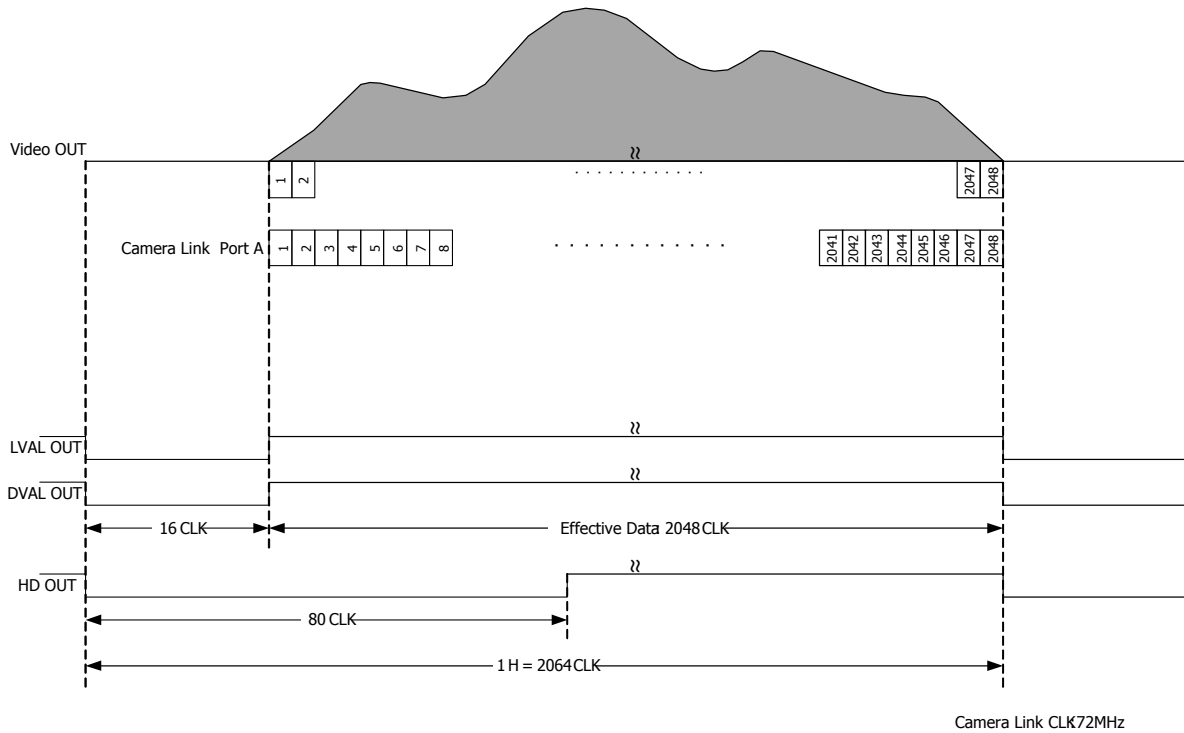

#### 7.2. Vertical Synchronous Signals Timing (1Tap Base Configuration Mode: 17fps)

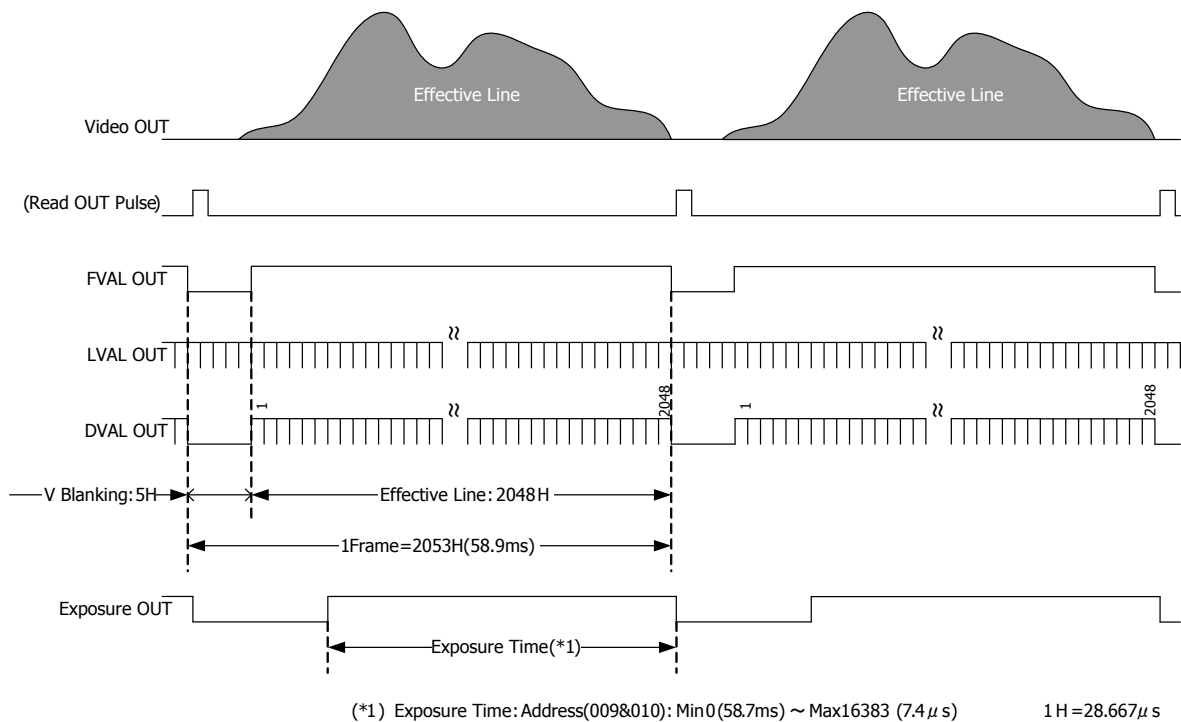

7.3. Horizontal Synchronous Signals Timing (2Tap Base Configuration Mode: 34fps)

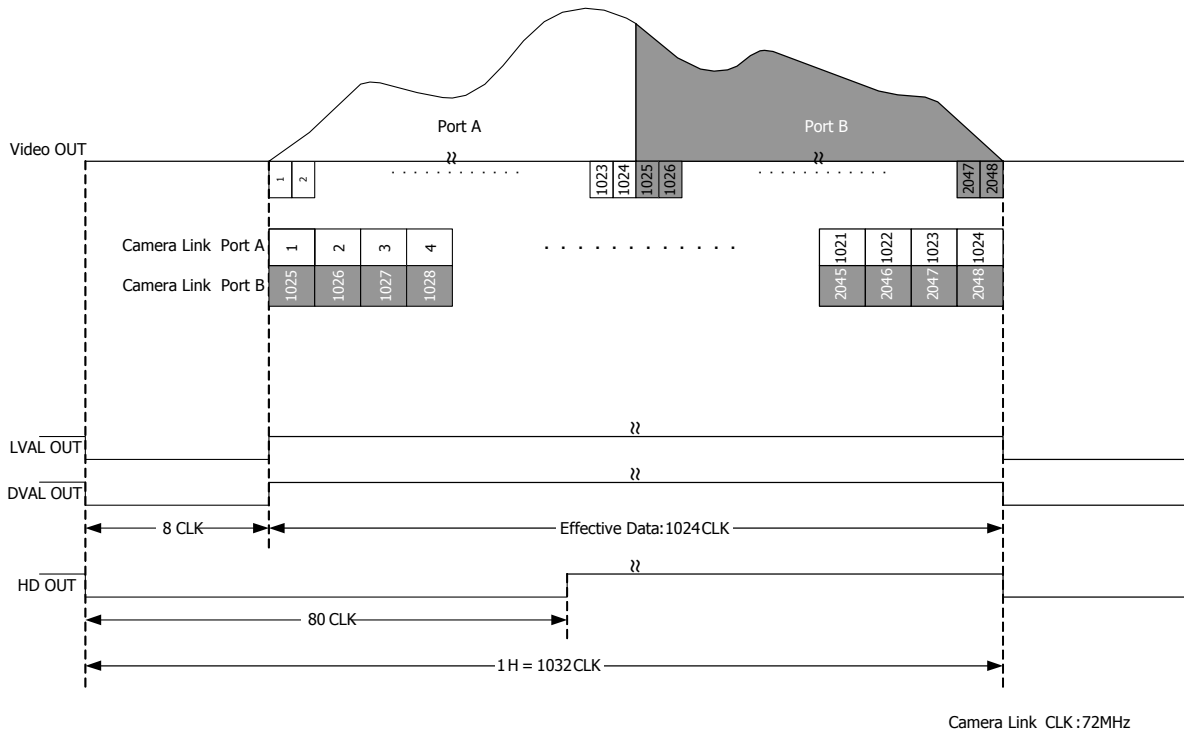

7.4. Vertical Synchronous Signals Timing (2Tap Base Configuration Mode: 34fps)

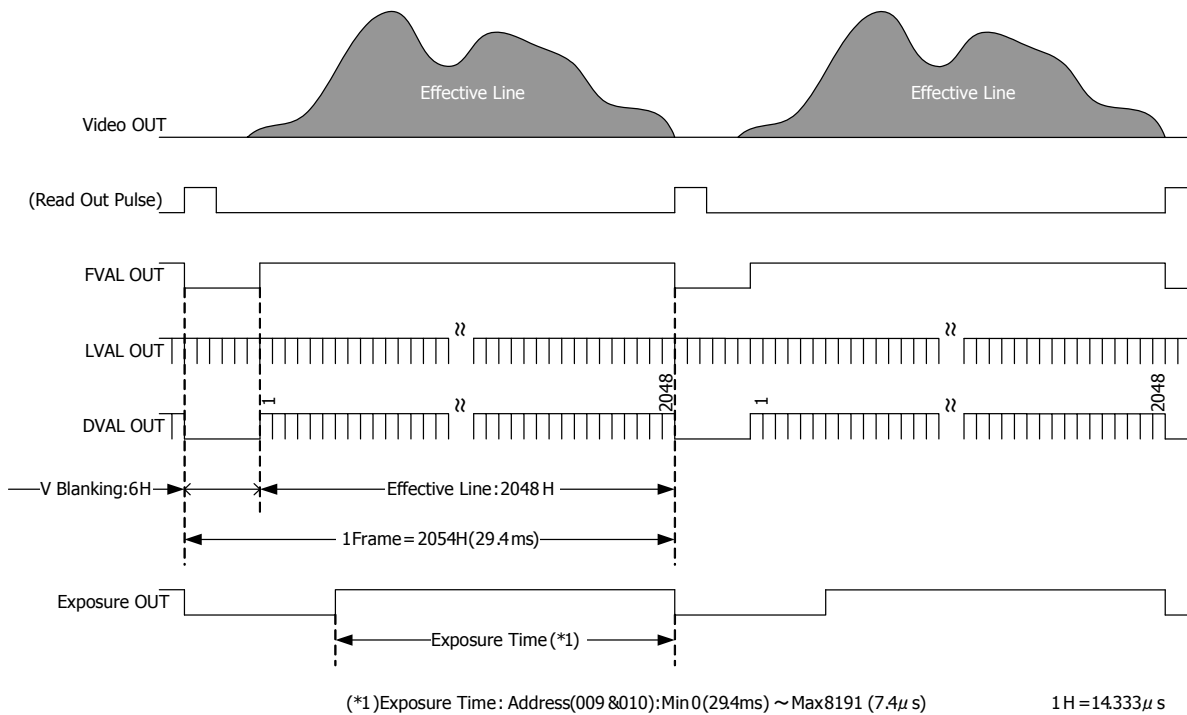





7.7. Horizontal Synchronous Signals Timing (8Tap Full Configuration Mode: 135fps)

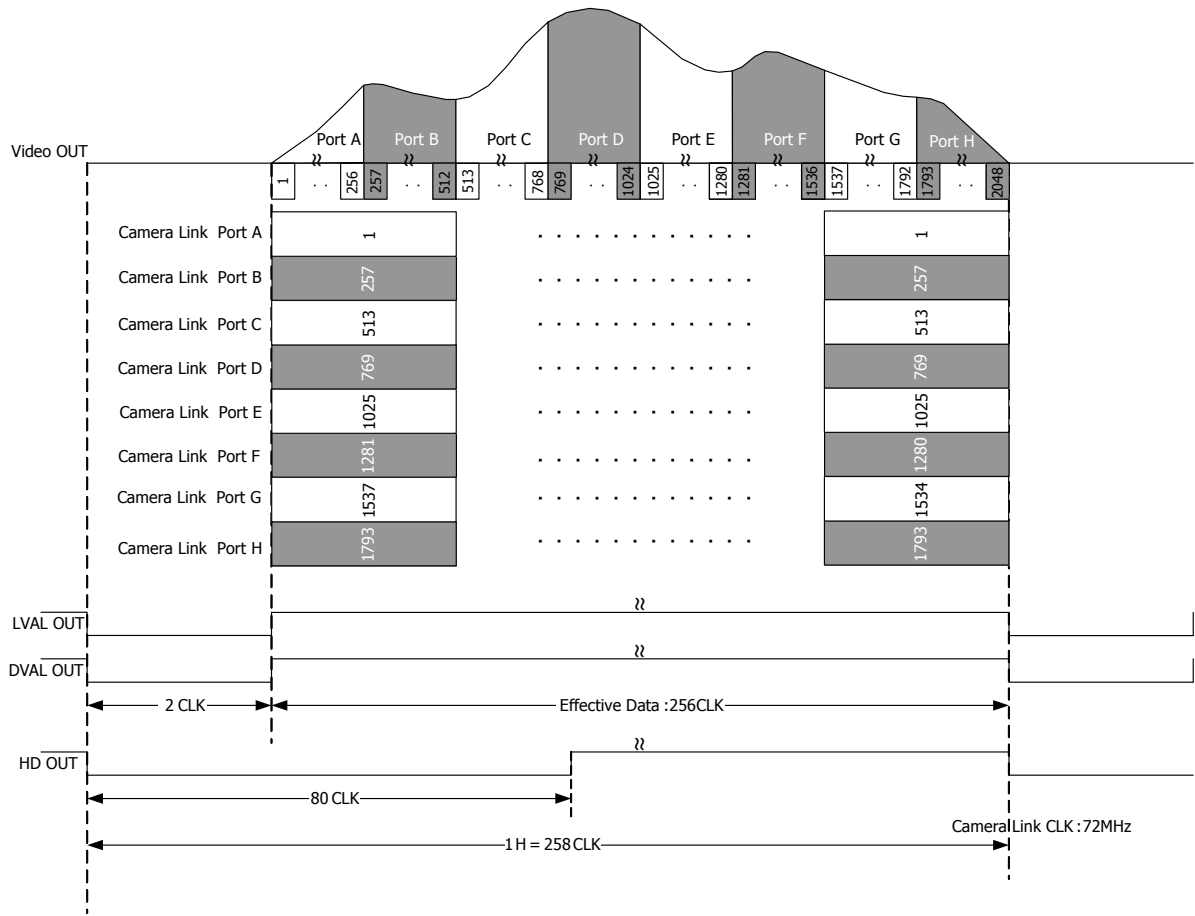

7.8. Vertical Synchronous Signals Timing (8Tap Full Configuration Mode: 135fps)

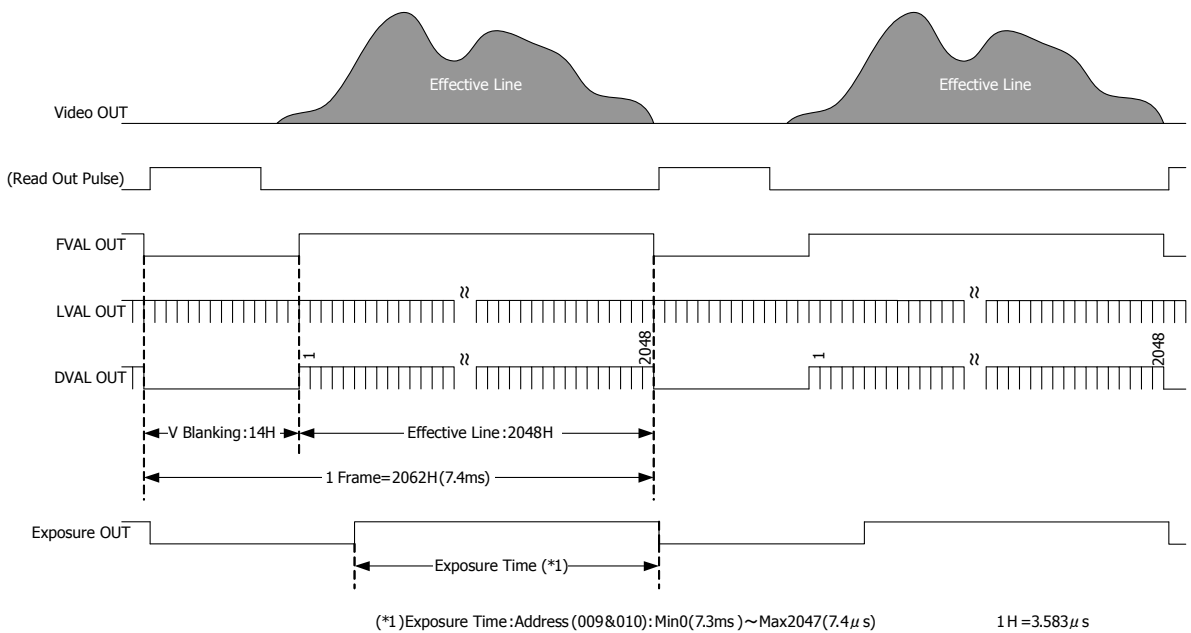

### 7.9. Fixed Trigger Shutter Mode

- This is the mode to start exposure with external input trigger signals, and set the exposure time with serial commands.
- Trigger operation is CLK Sync. HV-Sync Reset. The delay time (Exposure Time Delay) from detecting trigger edge in the camera to starting exposure is 370ns.
- Triggers can be accepted even when outputting video signals. However, trigger signals for exposure to start the next video output prior to the completion of video transmission for the prior video output signals can not be accepted.

If the edge part of trigger signals is overlapped with video outputting period, 1 line noise may be detected on the video output screen. To input trigger signals during video output period, set the data of address 018 to 001 (Trigger input signal, camera internal H sync ON). External trigger signals are synchronized with camera internal H signals so that approx. 3.583  $\mu$ s jitter to Exposure Time delay would occur.

- Trigger input during exposure time should be ignored. (Refer to the below A).

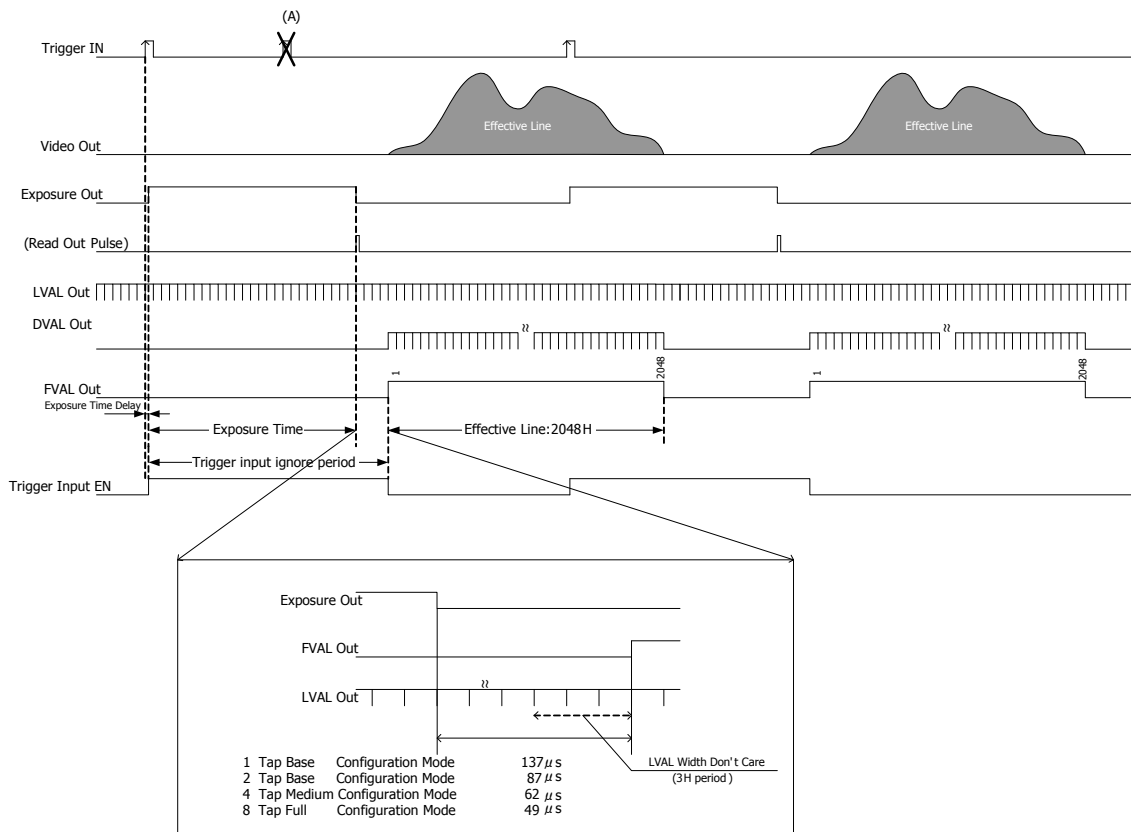

7.10. Pulse Width Trigger Shutter Mode

- This is the mode to start exposure with external input trigger signals, and set the exposure time with pulse width of the trigger signals.
- Trigger operation is CLK Sync. HV-Sync Reset. The delay time (Exposure Time Delay) from detecting trigger edge in the camera to starting exposure, and from detecting trigger end edge to completing exposure is 370ns.
- Pulse width is min. 10µs to approx. 2 frames. Functionally, there is no upper limitation, but noises such as dark noises and shadings may be noticeable at long time exposure.
- Triggers can be accepted even when outputting video signals. However, trigger signals for exposure to start the next video output prior to the completion of video transmission for the prior video output signals can not be accepted.

If the edge part of trigger signals is overlapped with video outputting period, 1 line noise may detected on the video output screen. To input trigger signals during video output period, set the data of address 018 to 001 (Trigger input signal, camera internal H sync ON). External trigger signals are synchronized with camera internal H signals so that approx. 3.583 µs jitter to Exposure Time delay would occur.

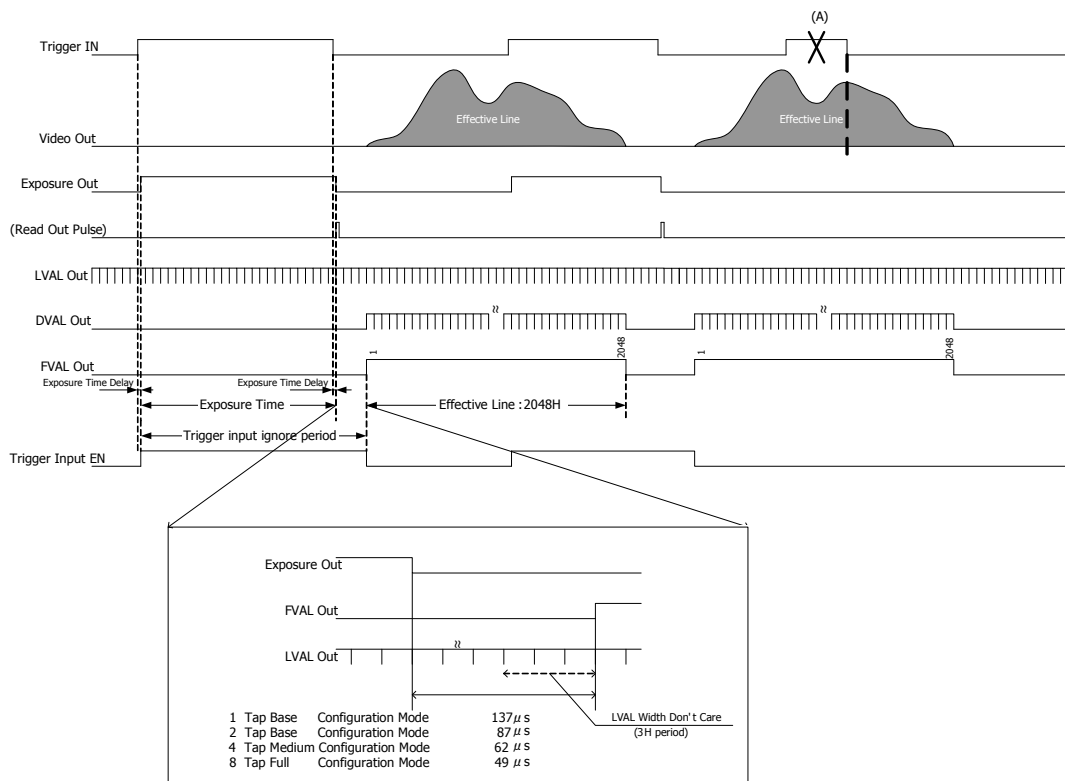

### 7.11. Internal Trigger Mode

- This is the mode to generate trigger signals in the camera taking the initial rise edge of external input trigger as the trigger. With serial commands, pulse width, cycle, and numbers to repeat for the trigger signals generated in the camera can be set.

Using internal trigger mode, several images can be taken automatically.

- While internal trigger mode operation, external trigger inputs shall be ignored in the camera.

(Refer to the below A)

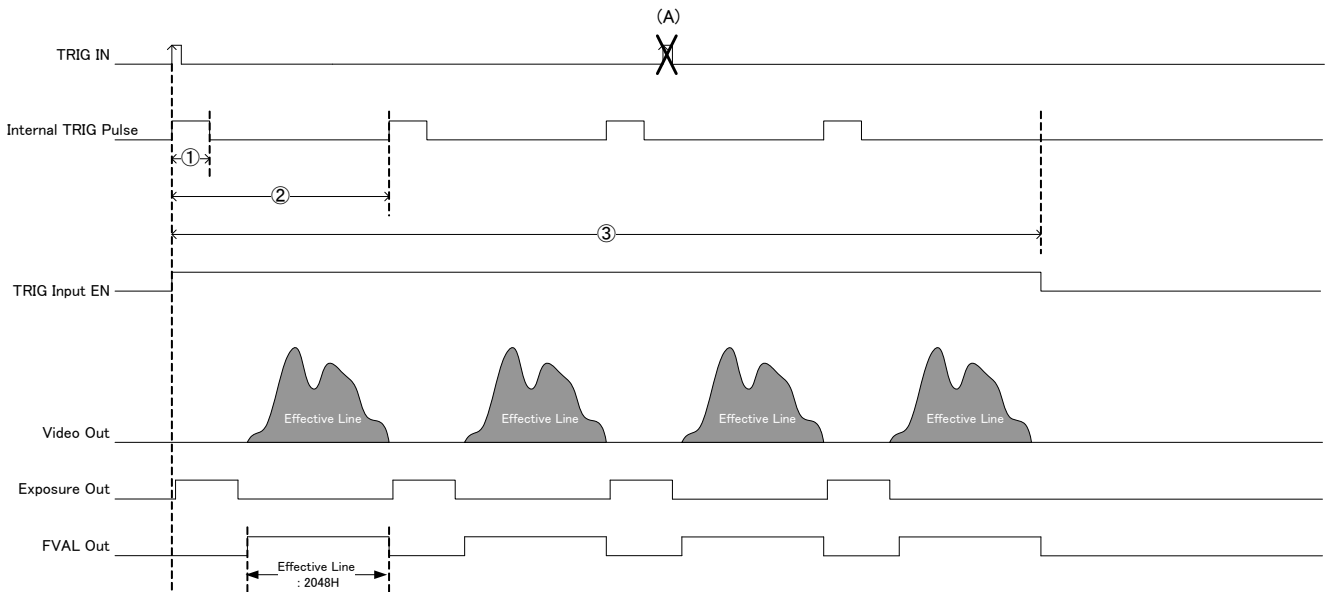

- ① : Internal Trigger Pulse Width ... (Address (040&041) + 1) × 3.583us : 3.583us ~ 234.8ms  
Setting Conditions: ② > ①
- ② : Internal Trigger Tact Timie ... (Address (042&043) + 1) × 3.583us : 3.583us ~ 234.8ms  
Setting Conditions: ② > ①, ② > 0
- ③ : Internal Trigger Repeat Number ... (Address 044) + 1time (Maximum repeating number: 32 Times)

8. Partial Scan Mode

□ Maximum 8 partial areas can be set by serial commands.

Example : 3 partial areas to be set.

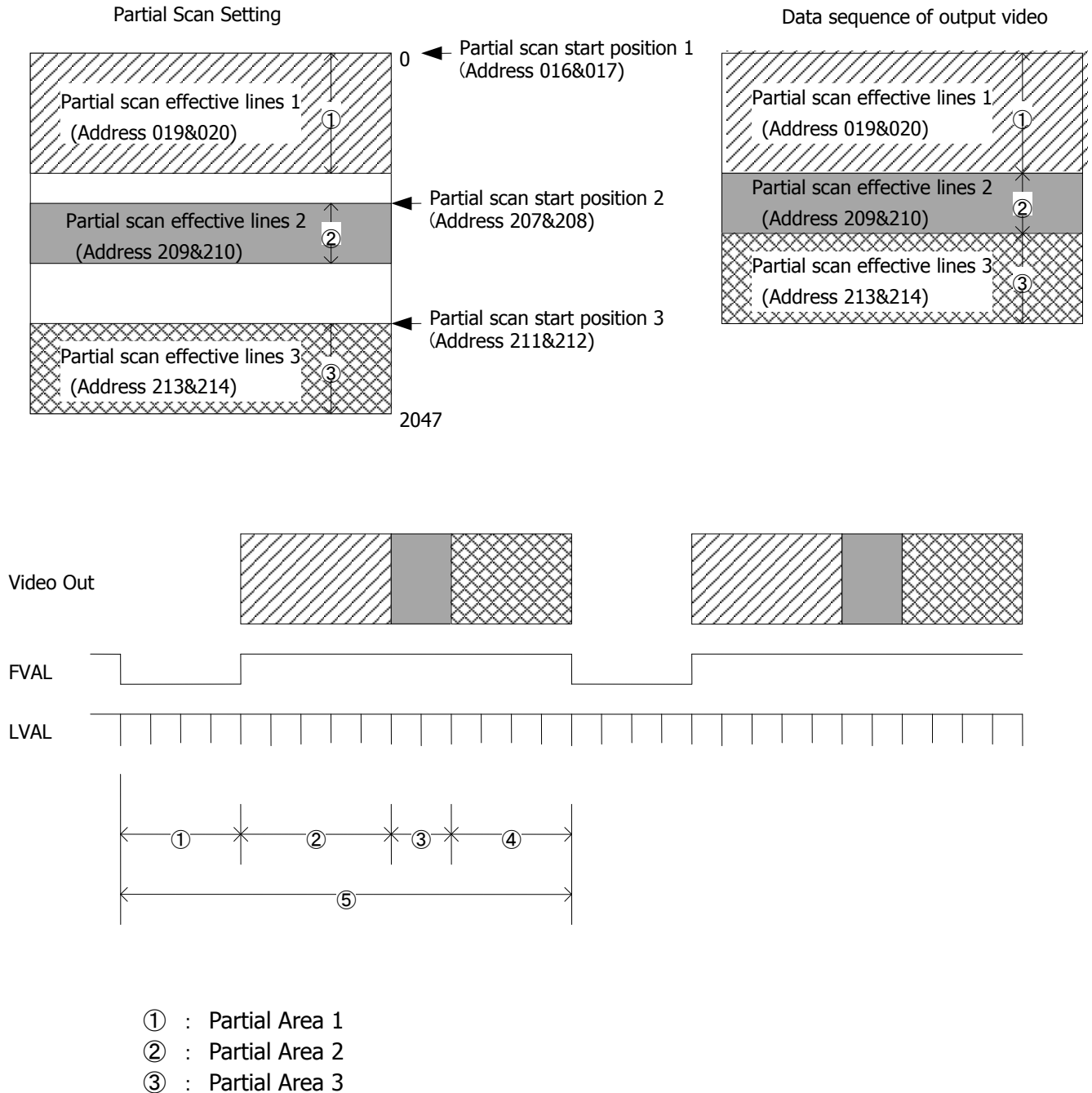

- When setting several partial scan areas, please set the start position and effective lines trying not to overlap the areas.
- When setting several areas, please set the areas in the numerical order of start position.
- Entire frame line numbers = V blanking line numbers +

Partial effective lines 1 + Partial effective lines 2 + ... + Partial effective lines 8

Note that "Sum total of partial effective line numbers (except V blanking lines) < 2048" should be met.

#### V Blanking line numbers

Camera Mode	V Blanking Lines
1Tap Base Configuration Mode	5H
2Tap Base Configuration Mode	6H
4Tap Medium Configuration Mode	9H
8Tap Full Configuration Mode	14H

- Frame rate = 1 / (Entire frame line numbers x Time for 1 line)

#### Time for 1 line

Camera Mode	Time for 1 Line
1Tap Base Configuration Mode	28.667 $\mu$ s
2Tap Base Configuration Mode	14.333 $\mu$ s
4Tap Medium Configuration Mode	7.167 $\mu$ s
8Tap Full Configuration Mode	3.583 $\mu$ s

- Setting Example

	Effective Lines	Frame Rate (Entire frame lines)			
		1Tap Mode	2Tap Mode	4Tap Mode	8Tap Mode
1(Min)	1 H	5814fps (6H)	9967fps (7H)	13953fps (10H)	18606fps (15H)
.	.				
Vertical:VGA equivalent	480 H	72fps (485H)	144fps (486H)	285fps (489H)	565fps (494H)
.	.				
Vertical:XGA equivalent	768 H	45fps (773H)	90fps (774H)	180fps (777H)	357fps (782H)
.	.				
Vertical:SXGA equivalent	1024 H	34fps (1029H)	68fps (1030H)	135fps (1033H)	269fps (1038H)
.	.				
Vertical:UXGA equivalent	1200 H	29fps (1205H)	58fps (1206H)	115fps (1209H)	230fps (1214H)
.	.				
2048 (Max:Full Frame)	2048 H	17fps (2053H)	34fps (2054H)	68fps (2057H)	135fps (2062H)

- Line numbers at partial scan setting, the number can be set from 1 line. However, consumption current will exceed several hundred mA so that the margin of camera power capacity shall be used.

## 9. Remote Communication Function

Via camera link cable, the camera can be controlled.

### (1) The settings for RS232C

Baud rate	: 9600bps (Initial Setting) 19200bps, 38400bps, 57600bps, 115200bps
Data	: 8bit
Stop bit	: 1bit
Parity	: None
XON/XOFF	: Not controlled

\* Baud rate can be changed with address 030. Please reboot the camera after changing baud rate setting.

### (2) Control code

- The total control code is 14 bytes, which conforms to ASCII code.
- The control code consists of camera No. process code, remote controller address, remote controller data, and CR. Execute Read/Write through PC, and the camera will reply the data.

1	2	3	4	5	6	7th Byte	8	9	10	11	12	13	14
Camera No.						Process code	Remote controller address			Remote controller data			CR
000000: fixed						"R" Read mode	Please refer to the address table of Section 5. Function Settings.			000~255			0 Dh
						"W" Write mode							
						"C" Camera mode							

#### Camera number

Camera No. is fixed with 6 bytes numerical strings, "000000".

#### Process code

Input any one of R, W, or C to the process code.

R (read mode) is to read the data of remote controller address.

Please be noted to set any dummy data (000~255) to 11<sup>th</sup> ~13<sup>th</sup>, since a command shall consists of 14 bytes.

W (write mode) is to write the data to the remote controller address.

Please be noted that the data cannot be saved into EEPROM of the camera.

(Reboot the camera, and the data is reset to the initial setting.)

To save the data into EEPROM, please refer to Section 5. Function Settings.

C is the code to send the data back from the camera.

**Note: Do not set code C when sending the data from PC side.**



X is the code to respond when error is detected by the camera side.

Details of the detected error can be checked with 4 lines of the 3<sup>rd</sup> to 6<sup>th</sup> byte.

0101: Abnormal address value

0102: Abnormal command

0103: Abnormal data value

0104: Abnormal data length (over 14byte)

Remote controller address

**Note: Do not write the data into the address other than specified, since it may cause the damages or malfunction of the camera.**

Remote controller data

Set the decimal number (000~255) for the remote controller data. Please be noted to set any dummy data at read control mode.

CR

Be sure to input "CR" to confirm the end of the command.

※ Note: The data set with 2 Byte shall be set with High Byte first, then set with Low Byte. The camera rewrites the internal register when receiving Low Byte.

(3) Data Save

Input data 083 or 053 into the address 255 to save the data to EEPROM.

(4) Initial Settings

Input data 083 or 053 into the address 254 to return to the initial settings.

## 10. Initial Settings

Function	Address	Data
Gain	001	0: 0dB
Shutter	002	0: 1/68s(OFF)
Trigger Shutter Mode	004	0: Normal Shutter Mode (Trigger OFF)
Trigger Polarity	011	0: Positive
Trigger Input	012	0: Camera Link (CC1) Input
Output Data Selection	013	0: 8bit output
Partial Scan Mode	015	0: Full Frame Scan Mode
Camera H Sync of Trigger Input Signal ON/OFF	018	0: OFF
Output Image Flip Vertical	021	0: Normal
General Purpose Input 1	022	1: Effective
Baud Rate	030	0: 9600bps
Camera Mode	031	1: 4Tap Medium Configuration Mode
Exposure Polarity	032	0: Positive
General Purpose Output 1	034	0: HD Output
General Purpose Output 2	035	1: FVAL Output
General Purpose Output 3	036	2: Exposure Output
General Purpose Output 4	037	3: TRIG Input EN Output
Camera Link SP Output	038	2: Exposure Output
Camera Link DVAL Output	039	4: DVAL Output

Initial Setting of camera rear switch

Power feeding selection                      SW1      CL side

11. CMOS Optical Axis Accuracy

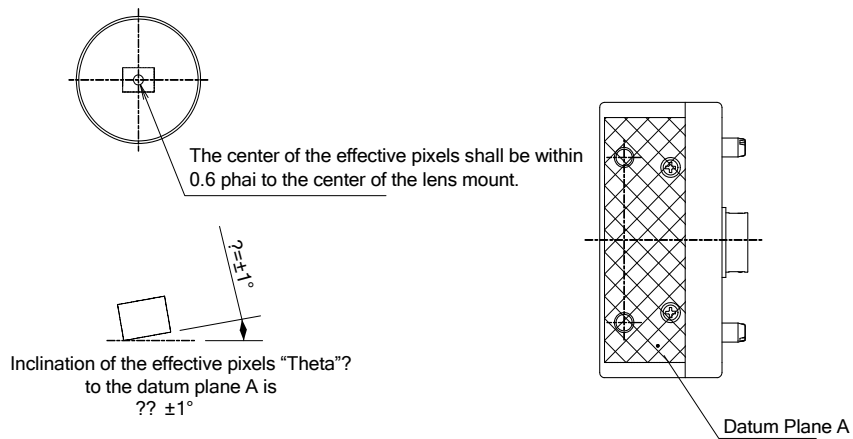
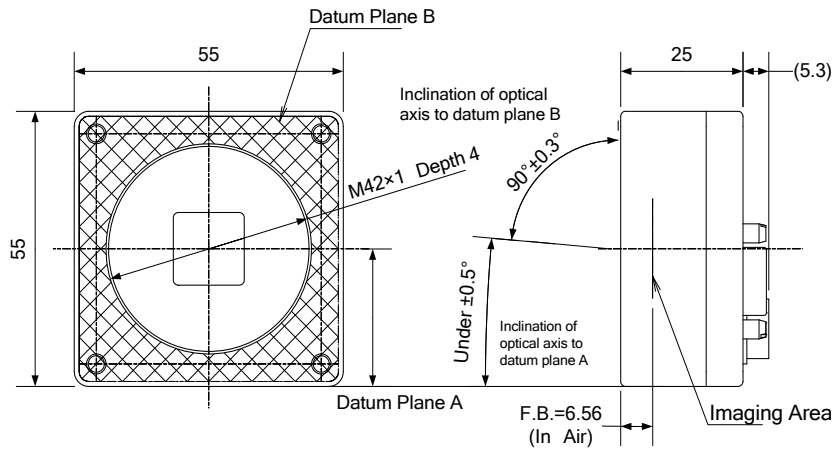

\*)Dimensions from datum plane A to the center of the lens mount

910-017-00-00  
(Unit:mm)

12. Dimensions

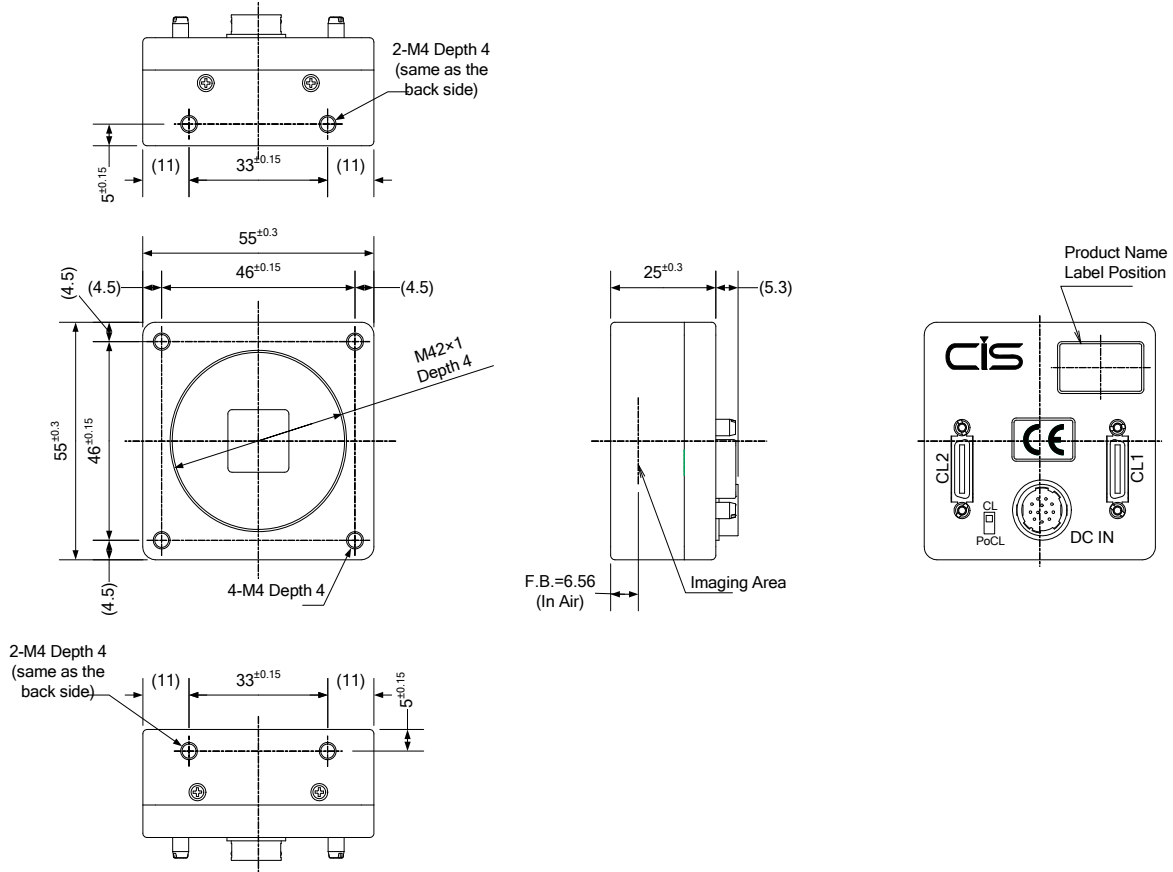

\* )Screw length of the lens from the lens mount surface shall be under 4mm.  
 And protruding portion shall be under 4mm.

999-556-00-01  
 (Unit:mm)

### 13. Cases for Indemnity (Limited Warranty)

We shall be exempted from taking responsibility and held harmless for damage or losses incurred by the user in the following cases.

- In case damage or losses are caused by fire, earthquake, or other acts of God, acts by third party, deliberate or accidental misuse by the user, or use under extreme operating conditions.
- In case indirect, additional, consequential damages (loss of business interests, suspension of business activities) are incurred as result of malfunction or non-function of the equipment, we shall be exempted from responsibility for such damages.
- In case damage or losses are caused by failure to observe the information contained in the instructions in this product specification & operation manual.
- In case damage or losses are caused by use contrary to the instructions in this product specification & operation manual.
- In case damage or losses are caused by malfunction or other problems resulting from use of equipment or software that is not specified.
- In case damage or losses are caused by repair or modification conducted by the customer or any unauthorized third party (such as an unauthorized service representative).
- Expenses we bear on this product shall be limited to the individual price of the product.

### 14. CMOS Pixel Defect

CIS compensates the noticeable CMOS pixel defects found at the shipping inspection prior to our shipment. On very rare occasions, however, CMOS pixel defects might be noted with time of usage of the products.

Cause of the CMOS pixel defects is the characteristic phenomenon of CMOS itself and CIS is exempted from taking any responsibilities for them. Should you have any questions on CMOS pixel defects compensation, please contact us.

### 15. Product Support

When defects or malfunction of our products occur, and if you would like us to investigate on the cause and repair, please contact your distributors you purchased from to consult and coordinate.